



CONTROL CONTRACTOR

SCALABLE, INTEGRATED, INSTALLED AUDIO SOLUTIONS

2024

VERSION 03.19.24



Contents Guide

About JBL.....	3-5
Ceiling Loudspeakers	6-15
Control 10 Series Blind-Mount Small Format.....	6
Control Contractor 20 Series Small Format.....	8
Control 40 Series Constant-Directivity.....	9
Control 200 Series Medium-Format.....	10
Control 300 Series Large-Format.....	11
CSS Commercial Series.....	12
8100 Series with Stylized Grille.....	13
Lay-In Ceiling-Tile Speakers.....	14
Pendant Loudspeakers	18-19
Control 60 Series.....	18-19
In-wall Loudspeakers	20
Control Contractor 100 Series.....	20
Surface-mount	21-35
Control Pro Series.....	21
CSS Commercial Series.....	22-23
Control Contractor 20 Series.....	26-28
Control 50 Series Subwoofer/Satellite.....	29
Control CRV Architectural.....	32
Control HST Wide-Coverage.....	33
SLP Series Sleek Low-Profile.....	34-35
Column	36-39
CBT Series.....	36-37
COL Series.....	38-39
Landscape Loudspeakers	40-41
Control 80 Series.....	40-41
GSF Series Garden Ground-Stake.....	42-43
GSB Series Garden In-Ground Subwoofers.....	44-45



About JBL

POWER AND VERSATILITY IS ONLY THE BEGINNING.

When it comes to the listening experience, JBL never ceases to push the boundaries. From its inception over 75 years ago, the brand has grown to become synonymous with epic sound. And while the enjoyment is instinctive, the science behind each and every innovation is precise and methodical. Passionate and gifted engineers and designers around the world devote themselves to developing JBL products and solutions that take listening to the next level - and they've been doing it since day one.

Today, JBL professional solutions encompass recording studios, movie theatres, tour sound, installed sound, arenas and stadiums, and much more. At the heart of each of these solutions is a meticulous attention to detail, a willingness to develop everything from the ground up, and an absolute dedication to giving artists outstanding sound, whether they're performing at a major music festival or busking on a street corner. And the technologies that JBL develops for its professional audience benefit all of JBL's listeners as they are distilled into smaller form factors, allowing people everywhere to enjoy professional quality sound at a convenient size and an affordable price.

Over the decades, JBL has contributed a remarkable number of industry firsts and technical innovations that further cemented its reputation as an audio pioneer, garnering Grammy® awards, Academy awards, and widespread

recognition from the world's most celebrated musicians and consumers along the way.

Expertly blending a bold vision of the future with the passion and talent of its engineers and designers, JBL develops its own solutions, invents its own technologies, and creates its own tools with a pioneering spirit that has defined the brand for the past 75 years. Today, JBL is present in more than 130 countries, encompasses an increasingly diverse range of next-level products and solutions, and has over 300 patents to its name, such as VGC™ transducer technology, Slip Stream™ low frequency port, Progressive Transition™ (PT) waveguides, and Plus One™ woofer cone technology.

Thanks to a truly exceptional dedication to constantly delivering exactly what customers desire, JBL sound has become part of the fabric of people's lives. Whether it's cinema sound that makes the movie-going experience more immersive, soundbars that transform the living room into a concert hall, portables that let listeners enjoy their favourite tunes wherever they go, gaming headsets that make players swear they've just stepped into the game, or in-car audio technology that turns the daily commute into a moment of pure listening pleasure, JBL fills listeners' lives with sound as it was meant to be heard.



A Journey of Engineering Excellence

Audio technology is at the core of everything JBL does. For over 75 years they have employed the best methodology and tools, developing everything from the ground up, guaranteeing their efforts exceed the needs and expectations of audio professionals throughout the world. Never straying from this exacting formula, this journey has produced a prolific list of audio achievements, ground-breaking technologies, revolutionary advances in the art and science of professional audio, many patents, and many awards. It's a journey that is legendary worldwide and has positioned JBL as the world leader in professional audio. Not just as a brand, but as a company known for consistently blending creativity and science as a manifestation of their passion for sound and commitment to those who create it.

Transducers.

The technology of transducers is truly the starting place for the entire JBL engineering legacy. Building on founder James B. Lansing's historic foundation, JBL engineers continue to break ground on new and better ways to design transducers, reaching beyond what is commonly understood as possible and consistently setting new performance benchmarks for the audio industry. Starting from scratch and often developing patents in the process, has resulted in technologies such as Differential Drive woofers,

CMCD Cone Midrange drivers, and the D2 Dual Voice Coil Compression Driver, that cover the entire practical bandwidth of professional audio devices. Simultaneously addressing performance-robbing challenges such as power compression, heat dissipation, distortion, component weight, and physical footprint, JBL has created a range of transducers that are unparalleled in their ability to deliver extraordinary performance throughout a wide range of applications.

Differential Drive®

JBL's exclusive dual voice coil, dual magnetic gap Differential Drive technology reduces weight while enhancing all critical performance parameters including better heat dissipation, lower power compression and higher dynamic range versus conventional single-coil designs. This allows very high output with minimal power compression, resulting in deep distortion-free bass even at very high SPL. Differential Drive® technology is now at the core of a full range of woofer models incorporated in many JBL loudspeaker systems from touring sound and fixed installation, to studio and cinema sound.

D2 Dual Diaphragm Dual Voice Coil Compression Driver

The revolutionary D2 Dual Driver dramatically improves the sound and performance of high frequencies, providing an extreme output advantage over conventional systems with significantly higher array power, reduced

distortion, double the number of voice coils and more than double the power handling. This results in a dramatic increase in pure high frequency sound pressure levels in the same physical footprint with a 30% reduction in weight.

Directivity.

Building better loudspeakers is only the first of many performance challenges that face all audio design engineers. Controlling the sound as it leaves the speaker enclosure is as critical to the performance of the system as the quality of the source component. The goal is always the same: create a consistent sound pattern throughout the desired vertical and horizontal plane without introducing artifacts, while ensuring the full bandwidth and SPL capability of the transducers, and providing a seamless transition from high frequency to low frequency components. JBL engineers relentlessly test new shapes and develop new materials to achieve the desired performance, often inventing new testing methodologies to ensure that nothing is left out of a thorough and rigorous examination of the design. The resulting technology has produced such ground-breaking designs as the Progressive Transition Waveguide, Image Control Waveguide, Slip Stream Port, Radiation Boundary Integrator, and Constant Curvature Waveguide. With multiple patents, and many successful installations in use worldwide, this critical component of JBL technology continues to evolve through our continuous pursuit of better, more accurate sound.

Radiation Boundary Integrator™ (RBI)

JBL's patented Radiation Boundary Integrator combines the high frequency and mid-range so the transition across each band is uninterrupted, undistorted and seamless. A patented,

tuned resonant chamber is integrated into the waveguide itself, effectively eliminating throat-related cancellations due to back pressure from the mid-range section. Our refined RBI waveguide implementation provides improved horizontal coverage - broader and more stable.

Testing.

All audio products have a useful life, and JBL engineers are committed to making that as long as possible, not only in terms of reliability, but also in terms of how good the sound is the very first time a system is turned on. Every JBL Professional product undergoes stringent testing above and beyond what the product would face when deployed in the real world.

JBL has multiple application specific anechoic testing chambers, and has developed the only known 'Speaker Shuffler' that allows rapid and precise re-positioning of speaker systems in the exact same space for truly accurate A/B testing. This rigorous, uncompromising adherence to testing results in continuous breakthroughs in performance and ensures that JBL users worldwide can always work with confidence.

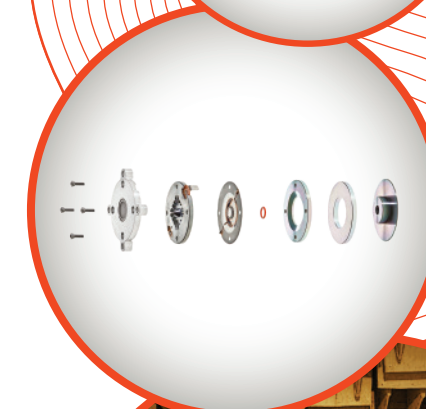
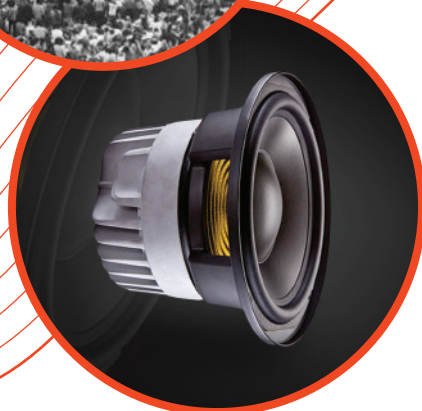
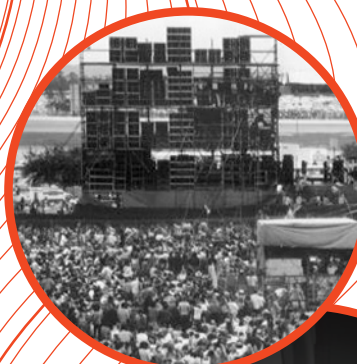

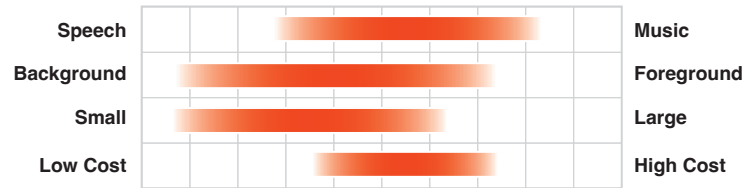

Control 20 Series

Small Format Ceiling Loudspeakers

JBL Control Contractor 20 Series small-format ceiling loudspeakers provide full-range, high-fidelity sound reinforcement for music and music-plus-paging systems. Innovative features like titanium-coated tweeters and JBL's proprietary diffraction-horn loading technology deliver wide even coverage. Models are packaged as complete assemblies including grille, backcan and tile rails, and can be installed without accessing areas above the ceiling. All loudspeakers feature JBL's exclusive SonicGuard™ overload protection, enabling higher operational levels and improved reliability.



White

Control 24CT MicroPlus

Two-Way 4.5" Ceiling Loudspeaker

Frequency Range (-10dB):
80 Hz to 25 kHz

Power Capacity
Cont. Pink Noise (100 hrs):
25 W

Impedance / Transformer:
NA / 25 W



White

Control 24C (CT) Micro

Two-Way 4.5" Ceiling Loudspeaker

Frequency Range (-10dB):
85 Hz to 25 kHz

Power Capacity
Cont. Pink Noise (100 hrs):
15 W

Impedance / Transformer:
8 ohms / 9 W

High Impedance Version Available
(Control 24CT Micro)



White

Control 24C (CT)

Two-Way 4" Coaxial Ceiling Loudspeaker

Frequency Range (-10dB):
80 Hz to 20 kHz

Power Capacity
Cont. Pink Noise (100 hrs):
40 W

Impedance / Transformer:
16 ohms / 30 W

High Impedance Version Available
(Control 24CT)

CT version available
Black and white



White

Control 26 (CT)

Two-Way 6.5" Coaxial Ceiling Loudspeaker

Frequency Range (-10dB):
75 Hz to 20 kHz

Power Capacity
Cont. Pink Noise (100 hrs):
75 W

Impedance / Transformer:
16 ohms / 60 W

High Impedance Version
(Control 26CT) & UL Life Safety
Compliant Version Available
(Control 26CT-LS)



White

Control 19CS (CST)

8" Ceiling Subwoofer

Frequency Range (-10dB):
42 Hz to 200 Hz

Power Capacity
Cont. Pink Noise (100 hrs):
100 W

Impedance / Transformer:
8 ohms / 75 W

High Impedance Version Available
(Control 19CST)



White

Control 45C/T

Two-Way 5.25" Coaxial Ceiling Loudspeaker

Frequency Range (-10dB):
55 Hz to 20 kHz

Power Capacity
Cont. Pink Noise (100 hrs):
75 W

Impedance / Transformer:
8 ohms / 60 W



White

Control 47C/T

Two-Way 6.5" Coaxial Ceiling Loudspeaker with Extended Bass

Frequency Range (-10dB):
55 Hz to 20 kHz

Power Capacity
Cont. Pink Noise (100 hrs):
75 W

Impedance / Transformer:
8 ohms / 60 W



White

Control 47HC

Two-Way 6.5" Coaxial Ceiling Loudspeaker, Narrow Coverage for High Ceilings

Frequency Range (-10dB):
55 Hz to 17 kHz

Power Capacity
Cont. Pink Noise (100 hrs):
75 W

Impedance / Transformer:
8 ohms / 60 W



White

Control 40CS/T

8" Ceiling Subwoofer with Crossover

Frequency Range (-10dB):
32 Hz to 300 Hz

Power Capacity
Cont. Pink Noise (100 hrs):
100 W

Impedance / Transformer:
8 ohms / 80 W

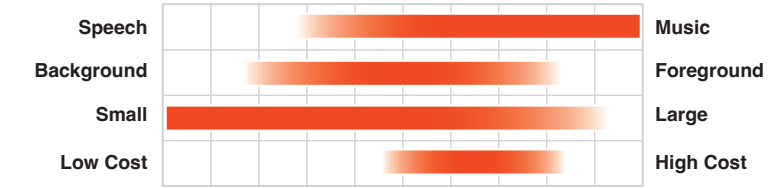

White

Control 42C

2.5" Ultra-Compact Ceiling Satellite Loudspeaker

Frequency Range (-10dB):
140 Hz to 20 kHz

Power Capacity
Cont. Pink Noise (100 hrs):
15 W

Impedance / Transformer:
16 ohms / NA



White

Control 47LP

Two-Way 6.5" Coaxial Low-Profile Ceiling Loudspeaker

Frequency Range (-10dB):
68 Hz to 20 kHz

Power Capacity
Cont. Pink Noise (100 hrs):
75 W

Impedance / Transformer:
8 ohms / 60 W

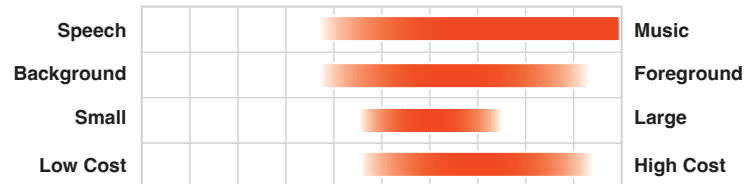

Control 200 Series

Medium-Format Ceiling Loudspeakers

Control 226C/T, 227C and 227CT are premium in-ceiling loudspeakers designed to meet the increasing market demand for premium quality sound in ceiling-mount applications. The Control 200 Series loudspeakers incorporate breakthrough performance features such as best-in-class constant-directivity pattern control to provide a consistent sound throughout the listening area. Especially wide coverage allows fewer loudspeakers to cover the space, reducing both the material and labor cost for the installation. The high-power Kevlar™-reinforced 6.5" (165 mm) low-frequency driver along with the titanium-diaphragm compression driver and advanced-technology steep-slope crossover provide superb, wide-bandwidth sound quality.



White

Control 226C/T

6.5" Coaxial Ceiling Loudspeaker with HF Compression Driver

Frequency Range (-10dB):
47 Hz to 19 kHz

Power Capacity
Cont. Pink Noise (100 hrs):
100 W

Impedance / Transformer:
8 ohms / 68 W



White

Control 227C

6.5" Coaxial Ceiling Loudspeaker with HF Compression Driver

Frequency Range (-10dB):
43 Hz to 19 kHz

Power Capacity
Cont. Pink Noise (100 hrs):
100 W

Impedance / Transformer:
8 ohms / 68 W

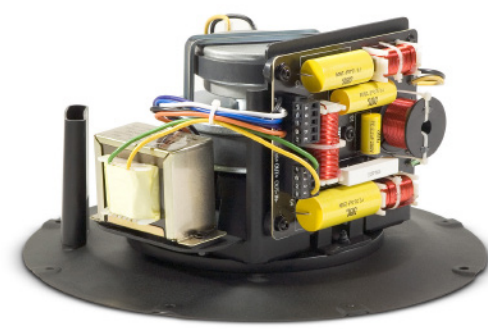

White

Control 227CT

6.5" Coaxial Ceiling Loudspeaker with HF Compression Driver

Frequency Range (-10dB):
43 Hz to 19 kHz

Power Capacity
Cont. Pink Noise (100 hrs):
100 W

Impedance / Transformer:
8 ohms / 68 W

High Impedance Version Available (227CT)

For Use with Pre-Install Backcan

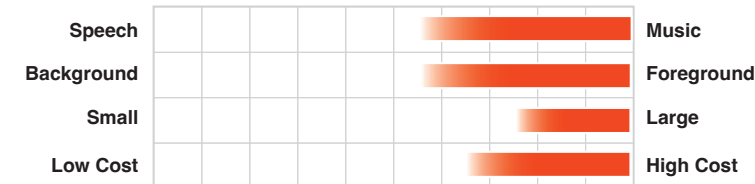

Control 300 Series

Large-Format Ceiling Loudspeakers

Control 300 Series represents the state of the art in large-format ceiling loudspeaker systems. True point-source coax designs, multiple power levels and transformer choices, plus an in-ceiling subwoofer, make it easy to fulfill any system performance requirements. Premium components include Kevlar™-reinforced cones, low-saturation transformers and legendary JBL compression drivers. Constant-directivity coverage, advanced high-slope crossover networks, low system distortion and smooth frequency response provides full, natural music along with exceptional speech intelligibility.



White

Control 321C (CT)

12" Coaxial Ceiling Loudspeaker with HF Compression Driver

Frequency Range (-10dB):
34 Hz to 18 kHz

Power Capacity
Cont. Pink Noise (100 hrs):
200 W

Impedance / Transformer:
5.6 ohms / 68 W

High Impedance Version Available (Control 321CT)

For Use with Pre-Install Backcan



White

Control 322C (CT)

High-output 12" Coaxial Ceiling Loudspeaker

Frequency Range (-10dB):
32 Hz to 20 kHz

Power Capacity
Cont. Pink Noise (100 hrs):
250 W

Impedance / Transformer:
8 ohms / 100 W

High Impedance Version Available (Control 322CT)

For Use with Pre-Install Backcan



White

Control 328C (CT)

8" Coaxial Ceiling Loudspeaker with HF Compression Driver

Frequency Range (-10dB):
45 Hz to 18 kHz

Power Capacity
Cont. Pink Noise (100 hrs):
150 W

Impedance / Transformer:
8 ohms / 68 W

High Impedance Version Available (Control 328CT)

For Use with Pre-Install Backcan



White

Control 312CS

High-Output 12" Ceiling Subwoofer Loudspeaker

Frequency Range (-10dB):
30 Hz to 4.5 kHz

Power Capacity
Cont. Pink Noise (100 hrs):
250 W

Impedance / Transformer:
8 ohms / NA

For Use with Pre-Install Backcan

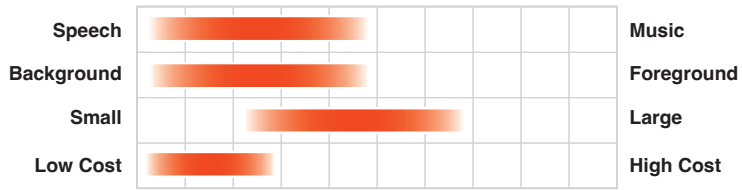

CSS Commercial Series

Ceiling Loudspeakers

CSS Commercial Series provide excellent performance for paging and background music applications including retail stores, restaurants, schools and other public facilities. High sensitivity speakers provide maximum sound level even at low tap settings, and wide dispersion ensures excellent coverage. The drivers all feature a full 25 mm (1 in) diameter voice coil with a Kapton™ coil-former and high-temperature wire for superior power dissipation and long-term reliability.



White

CSS8004

100 mm (4 in) Ceiling Speaker

Frequency Range (-10dB):
85 Hz to 18 kHz

Transformer:
5 W



White

CSS8008

200 mm (8 in) Ceiling Speaker

Frequency Range (-10dB):
55 Hz to 16 kHz

Transformer:
5 W



White

CSS8018

200 mm (8 in) Ceiling Speakers

Frequency Range (-10dB):
50 Hz to 17 kHz

Transformer:
10 W

8100 Series

Ceiling Speakers with a Stylized Grille

High-fidelity performance at a cost-effective price point, the 8100 Series is an easy to install loudspeaker solution for a wide variety of commercial sound applications. The 8100 Series feature high sensitivity drivers that deliver maximum sound levels using minimal amplifier power. With its contemporary grill design, 70V/100V taps and open-back design, the 8100 series brings elegance and performance to basic commercial sound systems, or any application not requiring a backcan for installation.

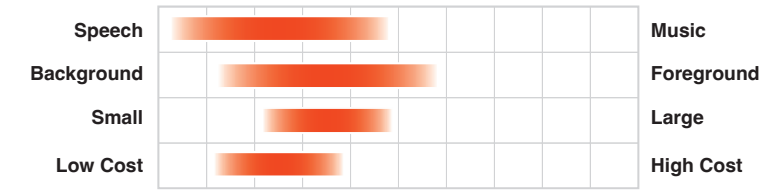

White

8124

4-inch, Full-range In-Ceiling Loudspeaker

Frequency Range (-10dB):
60 Hz to 18 kHz

Transformer:
6 W



White

8128

8-inch, Full-range In-Ceiling Loudspeaker

Frequency Range (-10dB):
50 Hz to 16 kHz

Transformer:
6 W



White

8138

8-inch Full-Range In-Ceiling Loudspeaker for use with Pre-Install Backcans

Frequency Range (-10dB):
95 Hz to 18 kHz

Transformer:
6 W

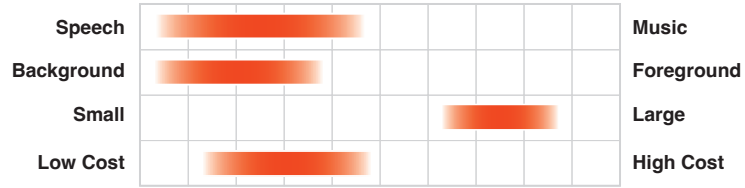

LCT Speakers

Lay-In Ceiling-Tile Speakers

LCT lay-in ceiling-tile speakers are full-range ceiling speakers designed to lay into suspended grid ceilings, with no cutting of ceiling tiles required, making for an easy and cost-effective installation with a minimum of mess. The low profile depth of only 103 mm (4 in) allows the speaker to fit in locations where deeper loudspeakers do not. These loudspeakers are designed to provide excellent performance for paging and light-to-medium music in a wide variety of applications.

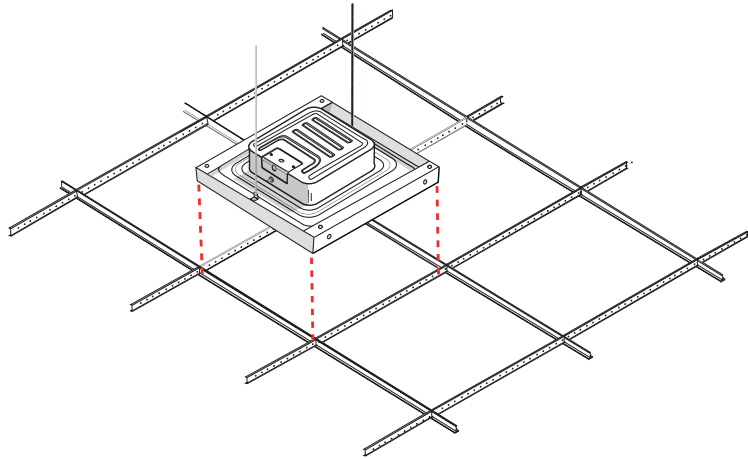

○ White

LCT 81C/T

Low-Profile Lay-In 2' x 2' Ceiling Tile

Frequency Range (-10dB):
100 Hz to 16 kHz

Transformer Taps:
10 W, 5 W, 2.5 W (plus 1.3 W @ 70V)



○ White

LCT 81C/TM

Low-Profile Lay-In 600 mm x 600 mm Metric Ceiling Tile Loudspeaker

Frequency Range (-10dB):
100 Hz to 16 kHz

Transformer Taps:
10 W, 5 W, 2.5 W (plus 1.3 W @ 70V)





VANs Showcase Store, South Korea

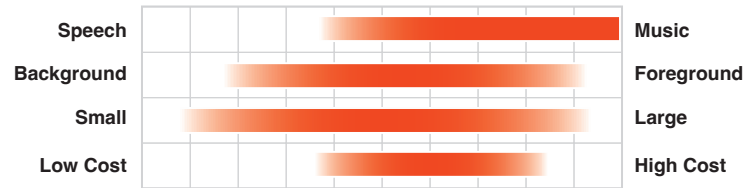

Radiation Boundary Integrator™ (RBI)

This unique JBL patented innovation combines a large diameter high-frequency waveguide with low-frequency projection apertures that work in tandem to provide a seamless integration of coverage between the two coaxially mounted drivers. The result is extremely even pattern control and coverage, where all listeners hear a consistent flat, frequency response. This often allows the use of fewer speakers.



Control 60 Series

Constant-Directivity Pendant Loudspeakers

The Control 60 Series brings renowned JBL sound to rooms and venues with open architecture or high ceilings, while providing superior voice and musical clarity for rooms with difficult acoustics. Easy to install stainless steel hanging hardware is included, featuring redundant suspension cables and UL listed adjustable height hangers. The Control 60 Series feature JBL-exclusive RBI Radiation Boundary Integration™ technology, providing true constant-directivity coverage. Exceptionally wide patterns reduce the number of loudspeakers needed to cover a space.



Black / White

Control 60PS/T

8" Pendant Subwoofer with Crossover

Frequency Range (-10dB):
42 Hz to 350 Hz

Power Capacity
Cont. Pink Noise (100 hrs):
150 W

Impedance / Transformer:
8 ohms / 110 W



Black / White

Control 62P

2.5" Ultra-Compact Mid-High Satellite Pendant Loudspeaker

Frequency Range (-10dB):
150 Hz to 20 kHz

Power Capacity
Cont. Pink Noise (100 hrs):
15 W

Impedance / Transformer:
16 ohms / NA



Black / White

Control 64P/T

4" Compact Full-Range Pendant Loudspeaker

Frequency Range (-10dB):
65 Hz to 15 kHz

Power Capacity
Cont. Pink Noise (100 hrs):
40 W

Impedance / Transformer:
8 ohms / 30 W



Black / White

Control 65P/T

Two-Way 5.25" Coaxial Pendant Loudspeaker

Frequency Range (-10dB):
55 Hz to 20 kHz

Power Capacity
Cont. Pink Noise (100 hrs):
75 W

Impedance / Transformer:
8 ohms / 60 W



Black / White

Control 67P/T

Two-Way 6.5" Coaxial Full-Range Pendant Loudspeaker

Frequency Range (-10dB):
58 Hz to 18 kHz

Power Capacity
Cont. Pink Noise (100 hrs):
75 W

Impedance / Transformer:
8 ohms / 60 W



Black / White

Control 67HC/T

Two-Way 6.5" Coaxial Narrow-Coverage Pendant Loudspeaker

Frequency Range (-10dB):
75 Hz to 17 kHz

Power Capacity
Cont. Pink Noise (100 hrs):
75 W

Impedance / Transformer:
8 ohms / 60 W



Black / White

Control 68HP

High-Power Pendant Loudspeaker

Frequency Range (-10dB):
52 Hz to 17 kHz

Power Capacity
Cont. Pink Noise (100 hrs):
150 W

Impedance / Transformer:
8 ohms / 68 W

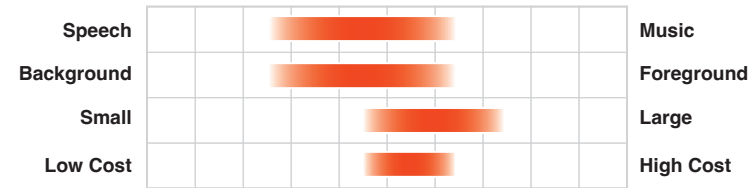

White

Control 126 W (WT)

6.5" In-Wall Loudspeaker

Frequency Range (-10dB):
38 Hz to 20 kHz

Power Capacity
Cont. Pink Noise (100 hrs):
50 W

Impedance / Transformer:
8 ohms / 30 W

High Impedance Version Available (Control 126WT)

Control 100 Series

In-Wall Loudspeakers

The Control 100 Series are in-wall loudspeakers designed for applications where minimal visual impact and premium sound quality is required. The Control 100 Series loudspeakers are voiced similarly to other JBL Control Contractor models, allowing mixing with surface-mount and in-ceiling loudspeakers within a single listening space. The sound quality makes these loudspeakers ideal for critical listening environments.



White

Control 128 W (WT)

8" In-Wall Loudspeaker

Frequency Range (-10dB):
30 Hz to 20 kHz

Power Capacity
Cont. Pink Noise (100 hrs):
60 W

Impedance / Transformer:
8 ohms / 50 W

High Impedance Version Available (Control 128WT)

Control Pro Series

Compact Loudspeaker Systems

The classic look of the JBL Control Series installation monitors stem from their initial development as recording studio reference monitors. Offering well-balanced sound, these loudspeakers are ideal for any installation requiring classic professional control monitor performance from a compact source.



Black / White

Control 1 Pro

Two-Way 5.25" Professional Compact Loudspeaker System

Frequency Range (-10dB):
80 Hz to 20 kHz

Power Capacity
Cont. Pink Noise (2 hrs):
150 W

Impedance / Transformer:
4 ohms / NA

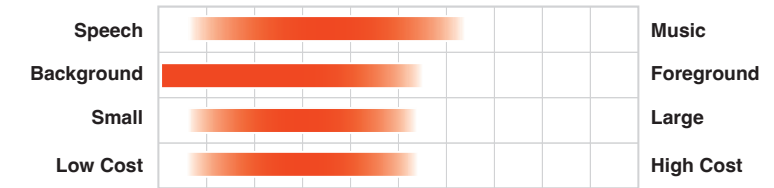

Black

Control 2P

Two-Way 5.25" Compact Powered Reference Monitors

Frequency Range (-10dB):
80 Hz to 20 kHz

Max SPL:
111 dB



Black / White

Control 5

Compact 6.5" Passive Two-Way Loudspeaker System

Frequency Response (+/-3dB):
75 Hz to 20 kHz

Power Capacity
Cont. Pink Noise (2 hrs):
175 W

Impedance / Transformer:
4 ohms / NA

Speech	██████████	Music	██████████
Background	██████████	Foreground	██████████
Small	██████████	Large	██████████
Low Cost	██████████	High Cost	██████████

CSS Series

Surface-Mount Loudspeakers

As an integral part of the JBL CSS Commercial System Solutions line-up of amplifiers, mixers, and wall controllers, CSS Series Surface-Mount Speakers provide excellent performance for paging and background music applications. CSS-H Paging Horns provide voice range clarity and IP65 capability for applications such as public address and announcement/paging systems. CSS-1S/T is a versatile, compact speaker for background music and speech reproduction.



○ White

○ White

● Black

CSS-H15

15 Watt Paging Horn

Frequency Range (-10dB):
400 Hz – 7.5 kHz

Power Capacity
Cont. Pink Noise (100 hrs):
15 W

Impedance / Transformer:
8 ohms / 15 W

CSS-H30

30 Watt Paging Horn

Frequency Range (-10dB):
380 Hz – 6 kHz

Power Capacity
Cont. Pink Noise (100 hrs):
30 W

Impedance / Transformer:
8 ohms / 30 W

CSS-1S/T

Compact Two-Way 100V/70V/8-Ohm Loudspeaker

Frequency Range (-10dB):
85 Hz – 18 kHz

Power Capacity
Cont. Pink Noise (100 hrs):
60 W

Impedance / Transformer:
8 ohms / 10 W



RYU Bar, India

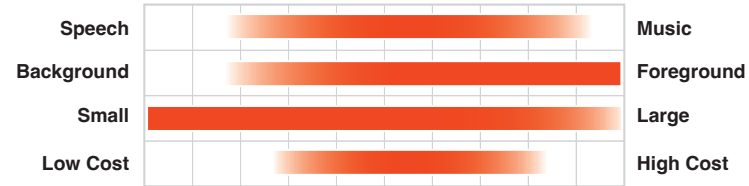

Control Contractor 20 Series

Surface-Mount Loudspeakers

Control Contractor 20 Series surface-mount loudspeakers and subwoofers deliver full, rich sound, deep bass extension, high SPL output, and wide consistent coverage for retail stores, restaurants, health clubs, theme parks, educational facilities or any application demanding top-quality sound reinforcement in a rugged, compact package. Built-in JBL Invisiball® mounting technology makes installation a breeze. Control Contractor surface-mount loudspeakers are voiced similarly to other JBL Control Contractor models, allowing them to be combined with in-wall and in-ceiling loudspeakers in a single listening space.



Black / White

Control 23-1 (L)

Two-Way 3" Ultra-Compact Surface-Mount Loudspeaker

Frequency Range (-10dB):
70 Hz to 20 kHz

Power Capacity
Cont. Pink Noise (100 hrs):
40 W

Impedance / Transformer:
8 ohms / 15 W

8-Ohm Low Impedance Only Version Available (Control 23-1L)



Black / White

Control 25-1 (L)

Two-Way 5.25" Compact Surface-Mount Loudspeaker

Frequency Range (-10dB):
60 Hz to 20 kHz

Power Capacity
Cont. Pink Noise (100 hrs):
75 W

Impedance / Transformer:
8 ohms / 30 W

8-Ohm Low Impedance Only Version Available (Control 25-1L)



Black / White

Control 28-1 (L)

Two-Way 8" High-Output Surface-Mount Loudspeaker

Frequency Range (-10dB):
45 Hz to 20 kHz

Power Capacity
Cont. Pink Noise (100 hrs):
90 W

Impedance / Transformer:
8 ohms / 60 W

8-Ohm Low Impedance Only Version Available (Control 28-1L)



Outdoor capabilities can be further enhanced with optional high-IP WeatherMax™ and/or Marine Kit grilles.

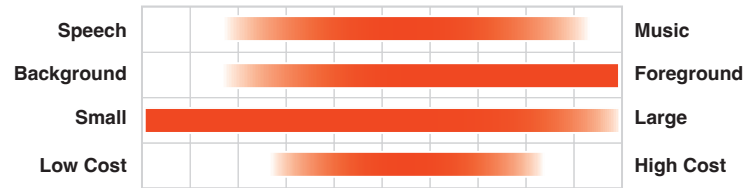

Black / White

Control 25AV

Two-Way 5.25" Video Shielded Compact Surface-Mount Loudspeaker

Frequency Range (-10dB):
70 Hz to 23 kHz

Power Capacity
Cont. Pink Noise (100 hrs):
100 W

Impedance / Transformer:
8 ohms / 60 W

Control Contractor 20 Series

Surface-Mount Loudspeakers

The Control Contractor 20 Series balances superior fidelity with versatility, ease-of-installation, and contemporary styling.



Black / White

Control 25AV-LS

Two-Way 5.25" Life Safety Compact Surface-Mount Loudspeaker

Frequency Range (-10dB):
90 Hz to 20 kHz

Power Capacity
Cont. Pink Noise (100 hrs):
100 W

Impedance / Transformer:
8 ohms / 60 W

EN-54 Compliant and UL Life Safety

Control 50 Series

Subwoofer-Satellite Loudspeaker System

The Control 50 Series subwoofer-satellite loudspeaker system provides high fidelity sound in any location where full-range high fidelity foreground/ background music is required from a surface-mount system. The Control 50S/T subwoofer can be utilized with either two of four Control 52 satellite loudspeakers. The Control 50 system is mono. Both the Control 50S/T and Control 52 can be intermixed in systems along with the in-ceiling and pendant subwoofer and satellite models to match the form factor requirements of a wide variety of applications and architectures.

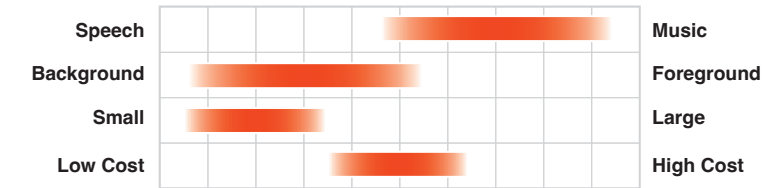

Black / White

Control 50 PACK

Surface-Mount Subwoofer-Satellite Loudspeaker System

Frequency Range (-10dB):
32 Hz to 20 kHz

Power Capacity
Cont. Pink Noise (100 hrs):
100 W

Impedance / Transformer:
4-8 ohms / 80 W



Black / White

Control 29AV-1

Two-Way 8" Surface-Mount Loudspeaker

Frequency Range (-10dB):
37 Hz to 18 kHz

Power Capacity
Cont. Pink Noise (100 hrs):
150 W

Impedance / Transformer:
8 ohms / 110 W



Black / White

Control 30

Three-Way 10" Surface-Mount Loudspeaker

Frequency Range (-10dB):
38 Hz to 17 kHz

Power Capacity
Cont. Pink Noise (100 hrs):
250 W

Impedance / Transformer:
4 ohms / 150 W



Black / White

Control 31

Two-Way 10" Surface-Mount Loudspeaker

Frequency Range (-10dB):
33 Hz to 19 kHz

Power Capacity
Cont. Pink Noise (100 hrs):
200 W

Impedance / Transformer:
8 ohms / 150 W



Black / White

Control SB2210

Dual 10" Compact Subwoofer

Frequency Range (-10dB):
38 Hz to 500 Hz

Power Capacity
Cont. Pink Noise (100 hrs):
400 W

Impedance / Transformer:
8 ohms / 300 W



Black / White

Control 52

Surface-Mount Satellite Loudspeaker

Frequency Range (-10dB):
140 Hz to 20 kHz

Power Capacity
Cont. Pink Noise (100 hrs):
15 W

Impedance / Transformer:
16 ohms / NA



Black / White

Control 50S/T

Surface-Mount Subwoofer

Frequency Range (-10dB):
32 Hz to 200 Hz

Power Capacity
Cont. Pink Noise (100 hrs):
100 W

Impedance / Transformer:
8 ohms / 80 W



Nam Nghi Resort's Rock Island Club, Vietnam

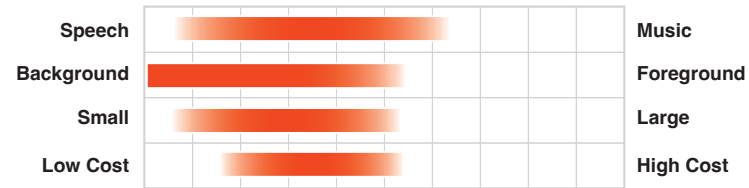

Black / White

Control CRV

Dual 4" Versatile High Design Loudspeaker

Frequency Range (-10dB):
80 Hz to 20 kHz

Power Capacity
Cont. Pink Noise (100 hrs):
60 W

Impedance / Transformer:
4 ohms / 30 W

Control CRV

Architectural Loudspeaker

The Control CRV brings high design and versatility to high-finish commercial venues that require a fashionable look. JBL Control CRV loudspeakers are exceedingly versatile, with multiple installation possibilities -- wall-mounted aimed straight out, angled down at a 45° aiming axis, mounted spanning the junction of a wall and ceiling, or spanning the junction of two walls. Two, three, or four (with optional PMB pole-mount bracket) Control CRV loudspeakers can be joined together to create loudspeaker solutions for a wide variety of coverage, appearance, and mounting requirements.

Control HST

Wide-Coverage Loudspeaker with HST Technology™

The Control HST utilizes JBL's patent pending Hemispherical Soundfield Technology™ to achieve extremely wide coverage of the listening space along with eliminating the primary wall reflection that tends to cause inconsistent sound when loudspeakers are attached to a wall. The wide hemispherical sound field covers from wall to wall, allowing a single loudspeaker to provide full-range sound to a large listening area. This can reduce the number of loudspeakers needed for covering a space, lowering the overall cost for a sound system.

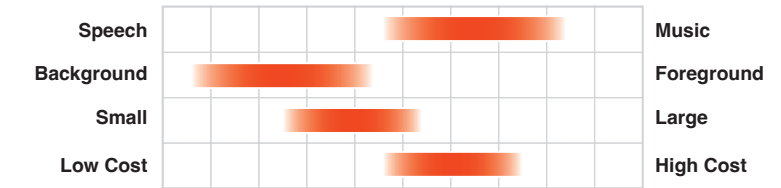

Black / White

Control HST

Wide-Coverage Loudspeaker with 5.25" LF and Dual Tweeters

Frequency Range (-10dB):
50 Hz to 20 kHz

Power Capacity
Cont. Pink Noise (100 hrs):
75 W

Impedance / Transformer:
8 ohms / 60 W



Coal Drops Yard, UK



SLP Series

Sleek Low-Profile Speakers

SLP sleek, low-profile full-range on-wall loudspeakers provide superior sound and broad, consistent coverage in a sleek, low-profile enclosure that deliver the legendary sound that JBL is known for. These elegantly finished speakers complement any décor and are available in black or white finishes. These stylish, low-profile speakers feature a downward tilt to their aim, allowing them to be installed flat to the wall, making them perfect for venues such as high-finish restaurants, hotels, resorts, retail stores, and any installation application calling for a discreet yet elegant look.

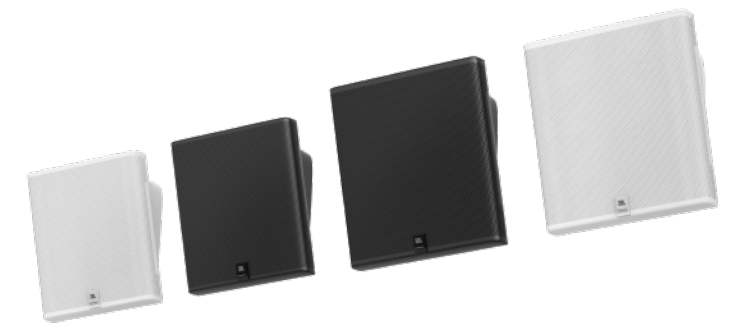
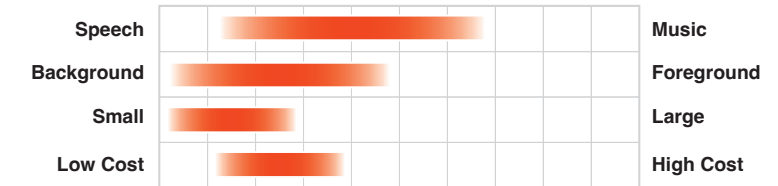

Black / White

SLP 12/T

Sleek, Low-Profile On-Wall Loudspeaker

Frequency Range (-10dB):
74 Hz to 20 kHz

Power Capacity
Cont. Pink Noise (100 hrs):
20 W (80 W Peak)

Impedance / Transformer:
8 ohms / 15 W

Black / White

SLP 14/T

Sleek, Low-Profile On-Wall Loudspeaker

Frequency Range (-10dB):
70 Hz to 10 kHz

Power Capacity
Cont. Pink Noise (100 hrs):
30 W (120 W Peak)

Impedance / Transformer:
8 ohms / 25 W



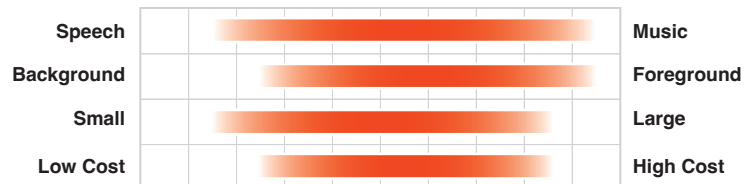

CBT Series

Passive Controlled-Coverage Column Loudspeakers

CBT Series has ushered in a new era for passive column speaker technology, providing Constant Beamwidth Technology™ with the ultimate in performance, versatility, and affordability. Designed for venues that might typically use larger point-and-shoot speakers, the CBT models incorporate technical advancements that allow them to vastly outperform competitive systems, with a level of user-friendliness that virtually eliminates the challenges of delivering great sound. Many of the models offer adjustable coverage capability to better fit the requirements of a variety of venues, plus user-variable voicing, overload protection, and outdoor capability, with SPL capability as high as 137 dB peak (134 dB continuous program), depending on the model and settings.



Black / White

CBT 200LA-1

200 cm (79 in) Tall Constant Beamwidth Technology Asymmetrical Column Speaker

Frequency Range (-10dB):
80 Hz to 20 kHz

Power Capacity
Cont. Pink Noise (100 hrs):
400 W

Impedance / Transformer:
8 ohms / 120 W + 120 W (dual)



Black / White

CBT 50LA-1

50 cm (21 in) Tall Constant Beamwidth Technology Column Speaker

Frequency Range (-10dB):
80 Hz to 20 kHz

Power Capacity
Cont. Pink Noise (100 hrs):
100 W

Impedance / Transformer:
8 ohms / 60 W



Black / White

CBT 50LA-LS

50 cm (21 in) Tall Column Loudspeaker with Eight 50 mm (2 in) Drivers and EN54:24 Certification

Frequency Range (-10dB):
120 Hz – 20 kHz

Power Capacity
Cont. Pink Noise (100 hrs):
100 W

Impedance / Transformer:
8 ohms / 60 W



Black / White

CBT 100LA-1

100 cm (39 in) Tall Constant Beamwidth Technology Line Array Column Loudspeaker

Frequency Range (-10dB):
80 Hz to 20 kHz

Power Capacity
Cont. Pink Noise (100 hrs):
200 W

Impedance / Transformer:
8 ohms / 120 W



Black / White

CBT 100LA-LS

100 cm (39 in) Tall Column Loudspeaker with Sixteen 50 mm (2 in) Drivers and EN54:24 Certification

Frequency Range (-10dB):
120 Hz – 20 kHz

Power Capacity
Cont. Pink Noise (100 hrs):
200 W

Impedance / Transformer:
8 ohms / 120 W



Black / White

CBT 1000

100 cm (40 in) Tall Very-High Output Asymmetrically Adjustable Extended-Range Line Array Column

Frequency Range (-10dB):
45 Hz – 20 kHz

Power Capacity
Cont. Pink Noise (100 hrs):
1000 W

Impedance / Transformer:
4 ohms



Black / White

CBT 70J-1

70 cm (27 in) Tall Two-Way Asymmetrical Line Array Column

Frequency Range (-10dB):
60 Hz – 20 kHz

Power Capacity
Cont. Pink Noise (100 hrs):
350 W

Impedance / Transformer:
8 ohms



Black / White

CBT 1000 + 1000E System

200 cm (80 in) Tall Very-High Output Asymmetrically Adjustable Extended-Range Line Array Column

Frequency Range (-10dB):
38 Hz – 20 kHz

Power Capacity
Cont. Pink Noise (100 hrs):
2000 W

Impedance / Transformer:
4 ohms



Black / White

CBT 70J-1 + 70JE-1 System

140 cm (54 in) Tall Two-Way Asymmetrical Line Array Column with Extension

Frequency Range (-10dB):
45 Hz – 20 kHz

Power Capacity
Cont. Pink Noise (100 hrs):
700 W

Impedance / Transformer:
4 ohms

Speech	██████████				Music
Background	██████████				Foreground
Small	██████████				Large
Low Cost	██████████				High Cost

COL Series

Slim Columns with Downward-Angled Aiming

The COL 600 and 800 models are discrete column loudspeakers with a downward tilt to their aim, allowing them to be installed flat to the wall while the sound is aimed toward the listening plane. Included L-brackets mount to the top and bottom (allowing horizontal rotation) or to left-right center points, and included wall bracket allows for further vertical aiming.



Black / White

COL600

600mm (24in) Tall Column Speaker

(2) 5 x 2.25 inch racetrack woofers and
(1) 1 inch tweeter

70 Hz – 20 kHz frequency range

Wide 160° horizontal and focused 110° vertical coverage

111 dB peak SPL
(105 dB continuous), 2 hrs



Black / White

COL800

800mm (32in) Tall Column Speaker

(4) 5-inch x 2.25-inch racetrack woofers and
(2) 0.8-inch tweeters

85 Hz – 20 kHz frequency range

Wide 160° horizontal and focused 60° vertical coverage

116 dB peak SPL
(110 dB continuous), 2 hrs



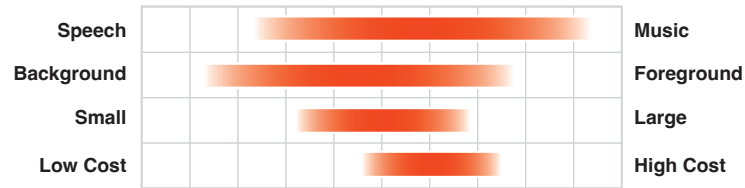

Control 80 Series

Landscape Loudspeakers

The Control 80 Series mushroom-type landscape loudspeakers feature high fidelity performance for outdoor on-ground use in applications such as hotels, restaurants, and shopping complexes. A wide frequency response and 360° of horizontal coverage ensure coverage of outdoor spaces with top-quality music and/or intelligible paging. Color is infused throughout the enclosure case to minimize the visual impact of the nicks and scratches that can happen with outdoor loudspeakers. The Control 80 Series are IP-56 rated as per IEC529. The Control 89MS can be added into a system to augment the low-frequency performance.



Green

Control 85M

Two-Way 5.25" Coaxial Mushroom Landscape Loudspeaker

Frequency Range (-10dB):
55 Hz to 18 kHz

Power Capacity
Cont. Pink Noise (100 hrs):
45 W

Impedance / Transformer:
8 ohms / 30 W



Green

Control 88M

Two-Way 8" Coaxial Mushroom Landscape Loudspeaker

Frequency Range (-10dB):
47 Hz to 16 kHz

Power Capacity
Cont. Pink Noise (100 hrs):
100 W

Impedance / Transformer:
8 ohms / 60 W



Green

Control 89MS

8" Mushroom Landscape Subwoofer Loudspeaker with Low-Pass Crossover

Frequency Range (-10dB):
40 Hz to 150 Hz

Power Capacity
Cont. Pink Noise (100 hrs):
100 W

Impedance / Transformer:
8 ohms / 80 W



Park Lane Hotel, Cyprus



GSF Series

Garden Ground-Stake Full-Range Speakers

Weather-resistant JBL GSF garden ground-stake full-range speakers provide superior fidelity and wide coverage in a range of outdoor commercial applications. Available in hunter green and tan finishes, these speakers are the perfect sound solution for diverse outdoor applications including shopping malls, theme parks, sports venues, hospitality venues, and any application calling for a stylish, robust, great-sounding landscape speaker system.

(includes L-bracket and ground stake)

Speech	[Progress bar]										Music
Background	[Progress bar]										Foreground
Small	[Progress bar]					[Progress bar]					Large
Low Cost	[Progress bar]										High Cost



Green / Tan

GSF3

Ground-Stake Landscape Loudspeaker

Frequency Range (-10dB):
74 Hz to 20 kHz

Power Capacity
Cont. Pink Noise (100 hrs):
15 W (60W Peak)

Impedance / Transformer:
8 ohms / 15 W



Green / Tan

GSF6

Ground-Stake Landscape Loudspeaker

Frequency Range (-10dB):
65 Hz to 20 kHz

Power Capacity
Cont. Pink Noise (100 hrs):
30 W (120 W Peak)

Impedance / Transformer:
8 ohms / 30 W

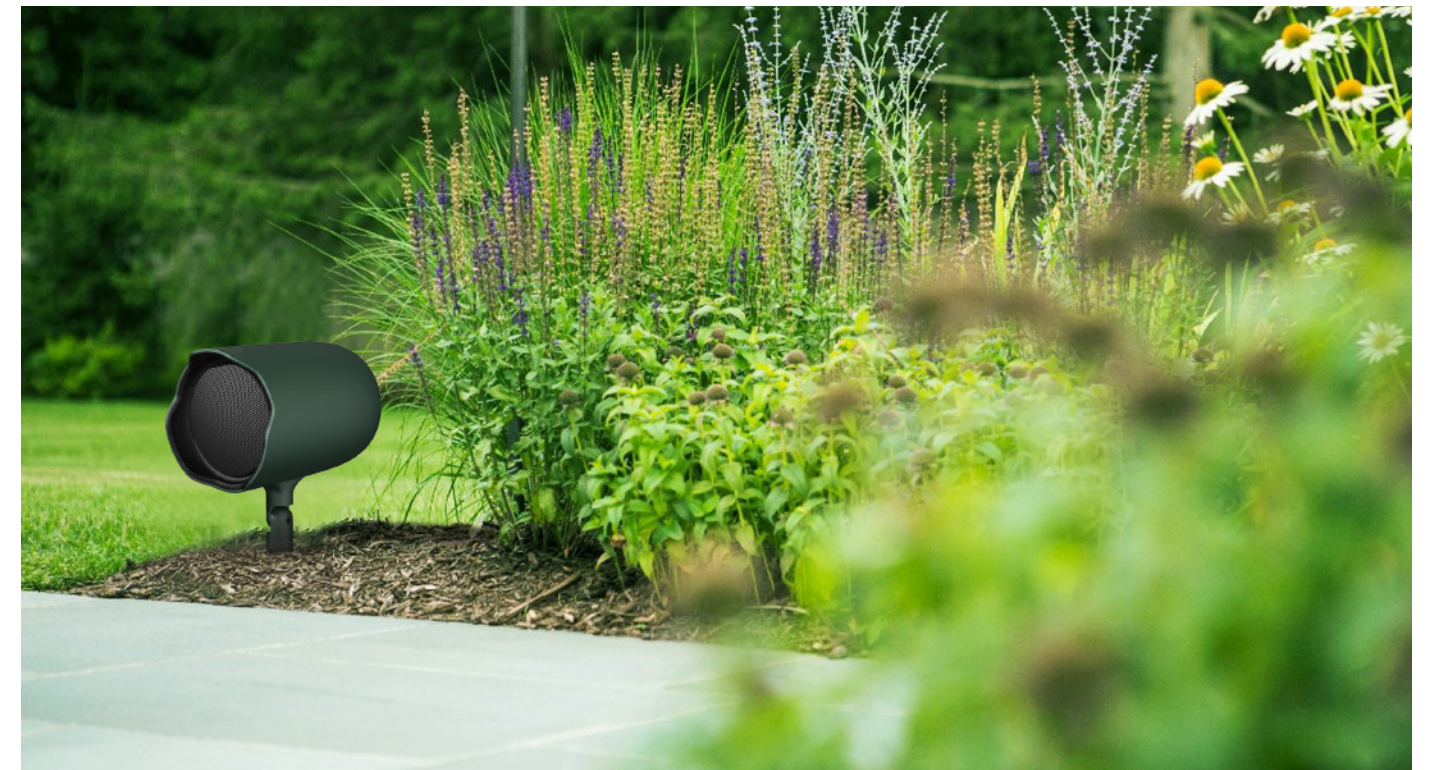

Understanding Control Contractor

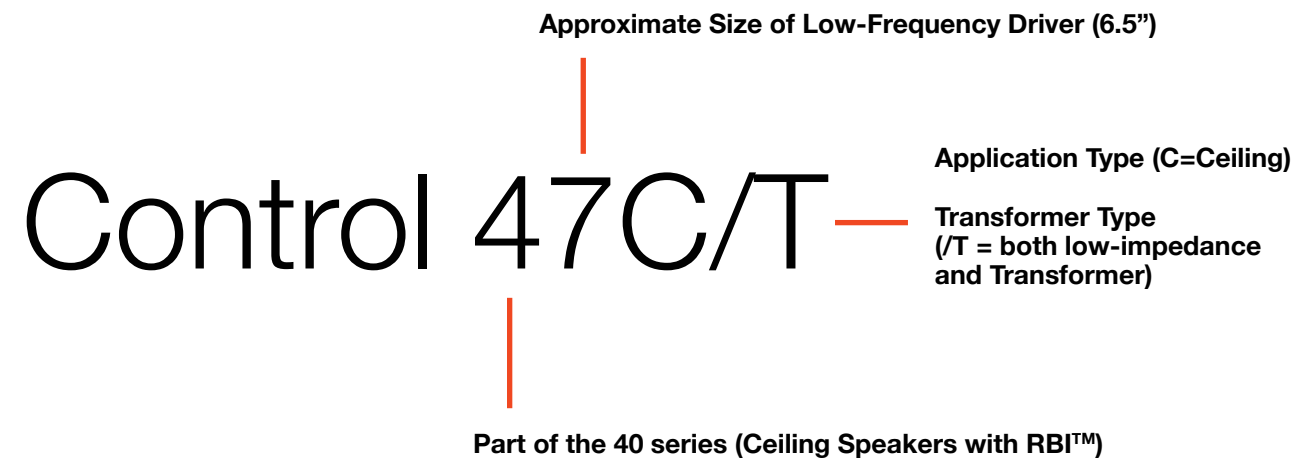

Annotations

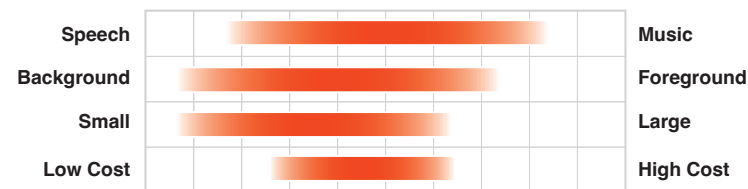

* Speech/Music range based on frequency response.
 * Any music-capable speaker is also speech capable.
 * Ratings based on best use of the speaker line's capabilities.
 * Background/Foreground range based on SPL capability for music content along with typical listening distances.
 * Small/Large range based on physical size.
 * Low-Cost/High-Cost range based on product's form-factor market.
 * For full technical specifications please refer to the product Spec Sheet which can be found on <https://jblpro.com/en>

Suffix and Prefix Guide

(not all accessories are shown in brochure):

- C.....Ceiling Speaker
- CT..... Ceiling Speaker with non-bypassable transformer, for 100V or 70V distributed speaker line
- C/T.....Ceiling Speaker with bypassable transformer, for either low-impedance or 100V/70V distributed speaker line
- LP.....Low-Profile Speaker (shallow, for use in ceilings with limited space above ceiling surface)
- HC.....High-Ceiling Speaker (narrow coverage, which works better for high ceiling applications)
- P..... Pendant Speaker
- P/T..... Pendant Speaker with bypassable transformer, for either low-impedance or 100V/70V distributed speaker line
- S..... Subwoofer (in most cases)
- C-VA..... Voice Announcement (special certification for use in voice announcement systems)
- LS..... UL Life Safety (may also have VA certification)
- AV..... Audio-Video Shielded (for use close to magnetically sensitive equipment)
- W.....In-Wall Speaker
- WT..... In-Wall Speaker with non-bypassable transformer, for 100V or 70V distributed speaker line
- MTC.....Mounting Bracket or accessory
- WMG and MK.....WeatherMax™ Grille and Marine-Kit (for extreme weather locations)
- UB.....U-Bracket
- CM.....Ceiling-Mount Adapter Arm (for surface-mount speakers)
- NC.....New-Construction Installation Bracket
- MR.....Plaster ("Mud Ring") Installation Bracket
- BB.....Backbox (or backcan)
- SG..... Square Grille
- RG..... Round Grille
- TB..... Tile Bridge
- TR..... Trim Ring



CONTROL CONTRACTOR

SCALABLE, INTEGRATED, INSTALLED AUDIO SOLUTIONS

2024



Find your local JBL representative: jblpro.com/en/distributors